

REVISIONS				DWN	DATE
ITEM REV	DWG REV	ECO	DESCRIPTION		
A	1	-	INITIAL RELEASE.	CPO	01-12-16

SIDE VIEW

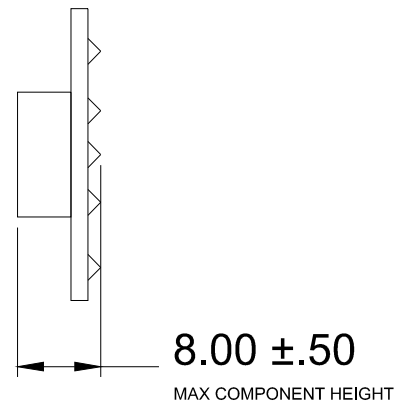

FRONT VIEW

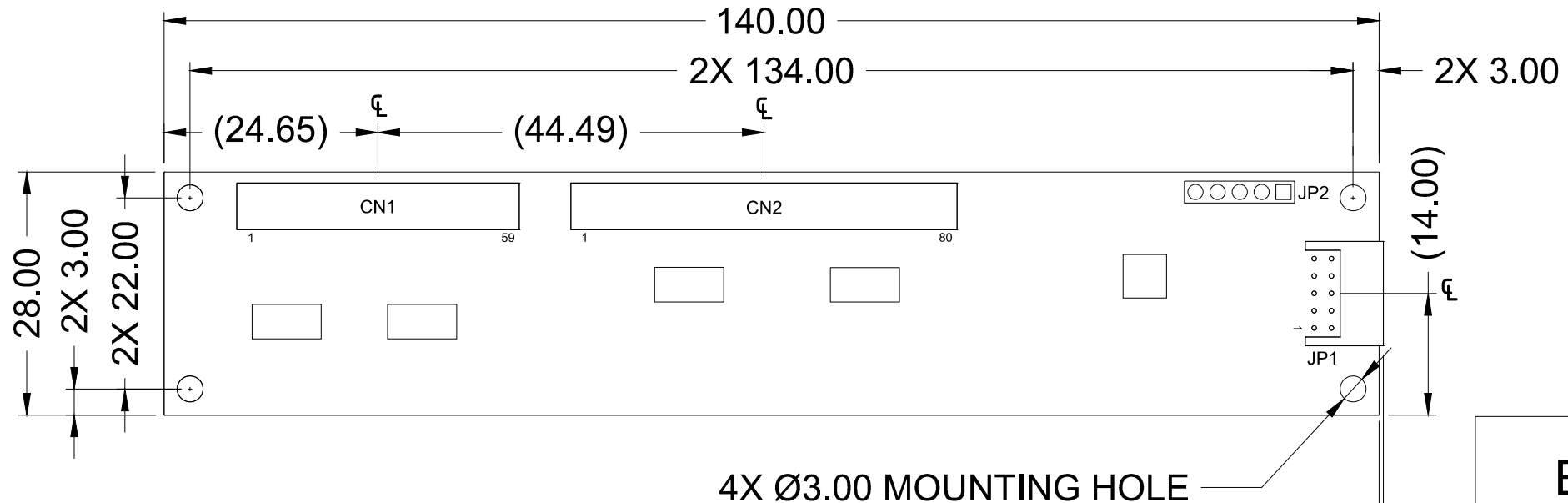

REAR VIEW

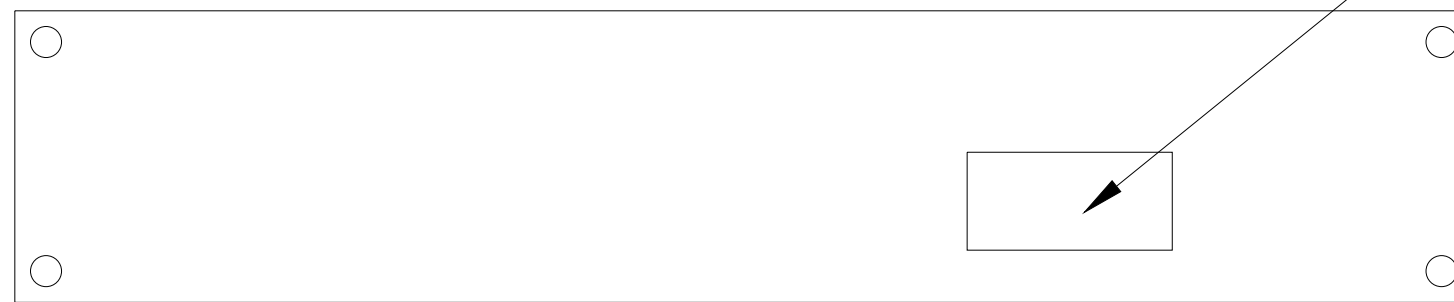

Backside Label

EXC325680CKG
0342
CT10315-A

JP2	1 GND_EARTH
	2 I2C_SDA
	3 I2C_SCL
	4 VDD
	5 I2C_INT

JP1	5 D-	6 RX
	4 D+	7 TX
	3 GND	8 GND
	2 VDD	9 VDD
	1 GND_E	10 GND_E



THIS CONFIDENTIAL DOCUMENT IS THE PROPERTY OF DAWAR TECHNOLOGIES, INC. AND SHALL NOT BE COPIED, REPRODUCED, DISCLOSED, AND/OR USED AS THE BASIS FOR MANUFACTURING OR SALE WITHOUT PERMISSION OF A DULY AUTHORIZED REPRESENTATIVE OF DAWAR TECHNOLOGIES, INC.

FIRMWARE NO. FW00342-A		ITEM/DRAWING NO. CT10315-A			DWG REV 1
DESCRIPTION 1+2+2 PCAP CONTROLLER	UNIT mm [INCH]	TOLERANCE ±0.25 [0.010] UNLESS SPECIFIED	SHEET 1 OF 1	DRAWN BY C. OSTROWSKI	DATE 01-12-16